

Material : High tensile steel  
 Safety factor : 5 times  
 Finish : Painted  
 Temperature range : -40°C up to +200°C, Polar Rated  
 Standard certification : Certificate of Conformity  
 3.1 material certificate EN 10204

Non-standard sizes or custom products available on request

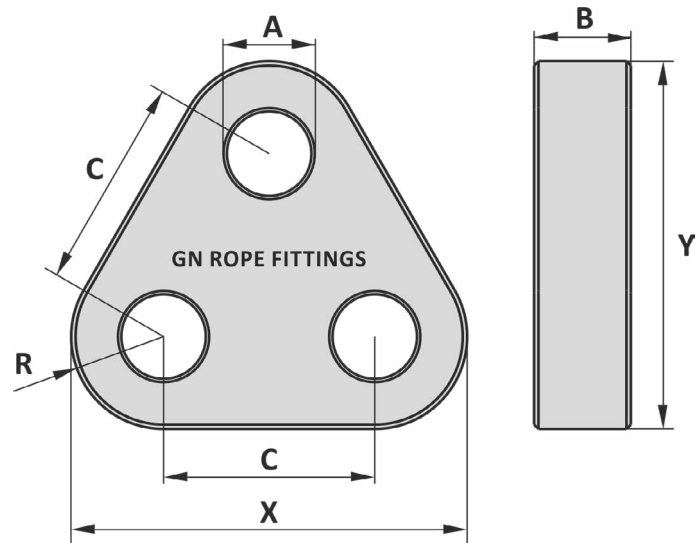
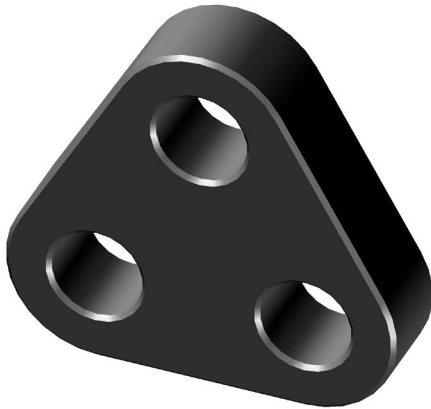

When there is a minimum distance between the triangle plate and the gap required, we advise to use washers. Spacers on the triangle plate available on request

Art. No.	WLL ton	MBL ton	A mm	B mm	C mm	R mm	X mm	Y mm	Weight kg
75001700	17	85	47	35	120	65	250	234	10
75002500	25	125	55	40	150	80	310	290	18
75003500	35	175	60	50	160	90	340	319	28
75005500	55	275	75	70	210	105	420	392	58
75008500	85	425	90	80	230	135	500	469	96
75012000	120	600	105	100	280	170	620	582	188
75015000	150	750	115	110	320	185	690	647	256
75017500	175	875	115	110	320	195	710	667	274
75020000	200	1000	140	120	390	215	820	768	390
75025000	250	1250	150	140	390	240	870	818	518
75030000	300	1500	160	150	420	250	920	864	617
75040000	400	2000	185	200	490	300	1090	1024	1170
75050000	500	2500	200	200	550	360	1270	1196	1619
75060000	600	3000	220	200	600	400	1400	1320	1972
75070000	700	3500	230	250	600	400	1400	1320	2452

Tolerance: Forged parts ± 5%, machined parts ± 1 mm

Art. No.	WLL ton	MBL ton	A inch	B inch	C inch	R inch	X inch	Y inch	Weight lbs
75001700	17	85	1 23/32	1 3/8	4 23/32	2 9/16	9 23/32	9 7/32	22
75002500	25	125	2 5/32	1 9/16	5 29/32	3 5/32	12 3/16	11 13/32	40
75003500	35	175	2 3/8	1 31/32	6 5/16	3 9/16	13 3/8	12 9/16	62
75005500	55	275	2 15/16	2 3/4	8 1/4	4 1/2	16 17/32	15 7/16	128
75008500	85	425	3 9/16	3 5/32	9 1/16	5 5/16	19 11/16	18 15/32	212
75012000	120	600	4 7/8	3 15/16	11 1/32	6 11/16	24 13/32	22 29/32	414
75015000	150	750	4 17/32	4 5/16	12 19/32	7 9/32	27 5/32	25 15/32	564
75017500	175	875	4 17/32	4 5/16	12 19/32	7 11/16	27 15/16	26 1/4	604
75020000	200	1000	5 1/2	4 23/32	15 11/32	8 15/32	32 9/32	30 1/4	860
75025000	250	1250	5 29/32	5 1/2	15 11/32	9 7/16	34 1/4	32 3/16	1142
75030000	300	1500	6 5/16	5 29/32	16 17/32	9 27/32	36 7/32	34	1360
75040000	400	2000	7 9/32	7 7/8	19 9/32	11 13/16	42 29/32	40 5/16	2579
75050000	500	2500	7 7/8	7 7/8	21 23/32	14 3/16	50	47 3/32	3569
75060000	600	3000	8 23/32	7 7/8	23 3/8	15 3/4	55 1/8	51 31/32	4348
75070000	700	3500	9 1/16	9 27/32	23 3/8	15 3/4	55 1/8	51 31/32	5406

Tolerance: Forged parts ± 5%, machined parts ± 1/32 inch

27-07-2015